

NEO H	Watt	B	A	C	D
NEO H 02	250	227	201	92	520
NEO H 04	400	227	201	137	565
NEO H 06	600	227	201	207	635
NEO H 08	800	236	302	212	750
NEO H 10	1000	268	302	239	809
NEO H 12	1200	356	302	326	984
NEO H 14	1400	263	604	227	1094
NEO H 20	2000	426	604	403	1433

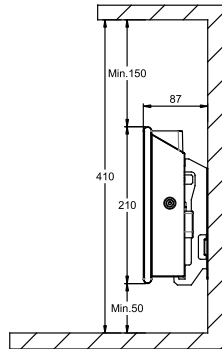

NEO L	Watt	B	A	C	D
NEO L 02	250	237	201	217	655
NEO L 04	400	253	302	228	783
NEO L 06	600	364	302	339	1005
NEO L 08	800	303	604	279	1186
NEO L 10	1000	386	604	390	1380
NEO L 12	1200	484	604	460	1548
NEO L 14	1400	343	1198	319	1860

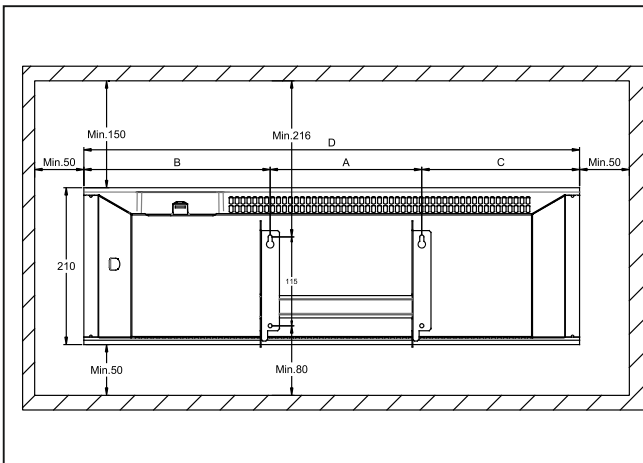